

AMSI-Glas AG

Glasapparate, Labor- u. Pilottechnik

Geismet 11, Postfach 22
CH-4317 Wegenstetten

Tel.: +41 61 873 90 93

Fax +41 61 873 90 94

www.amsi.ch

info@amsi.ch

AMSI-Normalschliff-Programm



Januar 2017 / Kapitel 1 op 2017

Alle Preise auf Anfrage!

AMSI-Glas AG

Glasapparate, Labor- u. Pilottechnik

Geismet 11, Postfach 22
CH-4317 Wegenstetten

Tel.: +41 61 873 90 93

Fax +41 61 873 90 94

www.amsi.ch

info@amsi.ch

01.001.xxx

Mittelhals-Rundkolben aus Borosilikatglas

Artikel-Nr.	Inhalt ml	NS			CHF / Stk.
01.001.001	10	14/23			
01.001.002	25	14/23			
01.001.003	50	14/23			
01.001.004	100	14/23			
01.001.005	250	14/23			
01.001.006	25	19/26			
01.001.007	50	19/26			
01.001.008	100	19/26			
01.001.009	250	19/26			
01.001.010	50	24/29			
01.001.011	100	24/29			
01.001.012	250	24/29			
01.001.013	500	24/29			
01.001.014	1000	24/29			
01.001.015	50	29/32			
01.001.016	100	29/32			
01.001.017	250	29/32			
01.001.018	500	29/32			
01.001.019	1000	29/32			
01.001.020	2000	29/32			
01.001.021	3000	29/32			
01.001.022	4000	29/32			
01.001.023	5000	29/32			
01.001.024	6000	29/32			
01.001.025	10000	29/32			
01.001.026	250	45/40			
01.001.027	500	45/40			
01.001.028	1000	45/40			
01.001.029	2000	45/40			
01.001.030	4000	45/40			
01.001.031	5000	45/40			
01.001.032	6000	45/40			
01.001.033	10000	45/40			
01.001.034	20000	60/46			



Andere Grössen auf Anfrage

AMSI-Glas AG

Glasapparate, Labor- u. Pilottechnik

Geismet 11, Postfach 22
CH-4317 Wegenstetten

Tel.: +41 61 873 90 93

Fax +41 61 873 90 94

www.amsi.ch

info@amsi.ch

01.001.1xx

Mittelhals-Rundkolben aus Borosilikatglas, Braunglas

Artikel-Nr.	Inhalt ml	NS			CHF / Stk.
01.001.101	10	14/23			
01.001.102	25	14/23			
01.001.103	50	14/23			
01.001.104	100	14/23			
01.001.105	250	14/23			
01.001.106	25	19/26			
01.001.107	50	19/26			
01.001.108	100	19/26			
01.001.109	250	19/26			
01.001.110	50	24/29			
01.001.111	100	24/29			
01.001.112	250	24/29			
01.001.113	500	24/29			
01.001.114	1000	24/29			
01.001.115	50	29/32			
01.001.116	100	29/32			
01.001.117	250	29/32			
01.001.118	500	29/32			
01.001.119	1000	29/32			
01.001.120	2000	29/32			
01.001.121	3000	29/32			
01.001.122	4000	29/32			
01.001.123	5000	29/32			
01.001.124	6000	29/32			
01.001.125	10000	29/32			
01.001.126	250	45/40			
01.001.127	500	45/40			
01.001.128	1000	45/40			
01.001.129	2000	45/40			
01.001.130	4000	45/40			
01.001.131	5000	45/40			
01.001.132	6000	45/40			
01.001.133	10000	45/40			
01.001.134	20000	60/46			

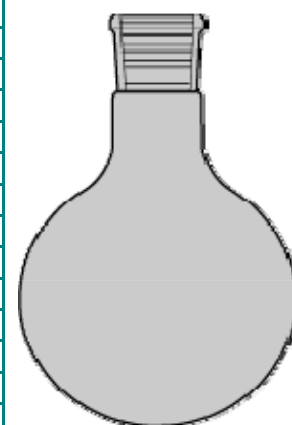

Andere Grössen auf Anfrage

AMSI-Glas AG

Glasapparate, Labor- u. Pilottechnik

Geismet 11, Postfach 22
CH-4317 Wegenstetten

Tel.: +41 61 873 90 93

Fax +41 61 873 90 94

www.amsi.ch

info@amsi.ch

01.002.xxx

Stehkolben aus Borosilikatglas

Artikel-Nr.	Inhalt ml	NS			CHF / Stk.
01.002.001	50	24/29			
01.002.002	100	24/29			
01.002.003	250	24/29			
01.002.004	500	24/29			
01.002.005	1000	24/29			
01.002.006	2000	24/29			
01.002.007	50	29/32			
01.002.008	100	29/32			
01.002.009	250	29/32			
01.002.010	500	29/32			
01.002.011	1000	29/32			
01.002.012	2000	29/32			
01.002.013	3000	29/32			
01.002.014	4000	29/32			
01.002.114	6000	29/32			
01.002.015	25	14/23			
01.002.016	50	14/23			
01.002.017	100	14/23			
01.002.018	250	14/23			
01.002.019	25	19/26			
01.002.020	50	19/26			
01.002.021	100	19/26			
01.002.022	250	19/26			

Andere Grössen auf Anfrage



01.002.1xx

Stehkolben aus Borosilikatglas, Braunglas

Artikel-Nr.	Inhalt ml	NS			CHF / Stk.
01.002.101	50	24/29			
01.002.102	100	24/29			
01.002.103	250	24/29			
01.002.104	500	24/29			
01.002.105	1000	24/29			
01.002.106	2000	24/29			
01.002.107	50	29/32			
01.002.108	100	29/32			
01.002.109	250	29/32			
01.002.110	500	29/32			
01.002.111	1000	29/32			
01.002.112	2000	29/32			
01.002.113	3000	29/32			
01.002.114	4000	29/32			
01.002.115	6000	29/32			



BRAUNGLAS

AMSI-Glas AG

Glasapparate, Labor- u. Pilottechnik

Geismet 11, Postfach 22
CH-4317 Wegenstetten

Tel.: +41 61 873 90 93

Fax +41 61 873 90 94

www.amsi.ch

info@amsi.ch

01.003.xxx

Birnkolben aus Borosilikatglas

Artikel-Nr.	Inhalt ml	NS			CHF / Stk.
01.003.001	10	14/23			
01.003.002	25	14/23			
01.003.003	50	14/23			
01.003.004	100	14/23			
01.003.005	250	14/23			
01.003.006	50	29/32			
01.003.007	100	29/32			
01.003.008	250	29/32			
01.003.009	500	29/32			
01.003.010	1000	29/32			



01.003.1xx

Birnkolben aus Borosilikatglas, Braunglas

Artikel-Nr.	Inhalt ml	NS			CHF / Stk.
01.003.101	10	14/23			
01.003.102	25	14/23			
01.003.103	50	14/23			
01.003.104	100	14/23			
01.003.105	250	14/23			
01.003.106	50	29/32			
01.003.107	100	29/32			
01.003.108	250	29/32			
01.003.109	500	29/32			
01.003.110	1000	29/32			



BRAUNGLAS

01.004.xxx

Rotationsverdampferkolben aus Borosilikatglas (Auffangkolben)

Mit Kugelschliff-Pfanne

Artikel-Nr.	Inhalt ml	KS			CHF / Stk.
01.004.001	50	35/25			
01.004.002	100	35/25			
01.004.003	250	35/25			
01.004.004	500	35/25			
01.004.005	1000	35/25			
01.004.006	2000	35/25			



AMSI-Glas AG

Glasapparate, Labor- u. Pilottechnik

Geismet 11, Postfach 22
CH-4317 Wegenstetten

Tel.: +41 61 873 90 93
Fax +41 61 873 90 94
www.amsi.ch
info@amsi.ch

01.004.xxx

Rotationsverdampferkolben, Fortsetzung

Mit PU-Kunststoff-Beschichtung					
Artikel-Nr.	Inhalt ml	KS			CHF / Stk.
01.004.007	50	35/25			
01.004.008	100	35/25			
01.004.009	250	35/25			
01.004.010	500	35/25			
01.004.011	1000	35/25			
01.004.012	2000	35/25			



PU-beschichtet

01.004.1xx

Rotationsverdampferkolben aus Borosilikatglas, birnenförmig

Zentriert

Artikel-Nr.	Inhalt ml	NS			CHF / Stk.
01.004.101	10	14/23			
01.004.102	25	14/23			
01.004.103	50	14/23			
01.004.104	100	14/23			
01.004.105	50	29/32			
01.004.106	100	29/32			
01.004.107	250	29/32			
01.004.108	500	29/32			
01.004.109	1000	29/32			
01.004.110	2000	29/32			
01.004.111	3000	29/32			
Braunglas					
01.004.112	10	14/23			
01.004.113	25	14/23			
01.004.114	50	14/23			
01.004.115	100	14/23			
01.004.116	50	29/32			
01.004.117	100	29/32			
01.004.118	250	29/32			
01.004.119	500	29/32			
01.004.120	1000	29/32			
01.004.121	2000	29/32			
01.004.122	3000	29/32			



BRAUNGLAS

Rotationsverdampferkolben mit Schikanen auf Anfrage

AMSI-Glas AG

Glasapparate, Labor- u. Pilottechnik

Geismet 11, Postfach 22
CH-4317 Wegenstetten

Tel.: +41 61 873 90 93

Fax +41 61 873 90 94

www.amsi.ch

info@amsi.ch

01.005.xxx

Spitzkolben aus Borosilikatglas

Artikel-Nr.	Inhalt ml	NS			CHF / Stk.
01.005.001	10	14/23			
01.005.002	25	14/23			
01.005.003	50	14/23			
01.005.004	100	14/23			
01.005.005	250	14/23			
01.005.106	100	29/32			
01.005.006	150	29/32			
01.005.007	250	29/32			
01.005.008	500	29/32			
01.005.009	1000	29/32			
Braunglas					
01.005.010	10	14/23			
01.005.011	25	14/23			
01.005.012	50	14/23			
01.005.013	100	14/23			
01.005.014	250	14/23			
01.005.015	150	29/32			
01.005.016	250	29/32			
01.005.017	500	29/32			
01.005.018	1000	29/32			



BRAUNGLAS

Andere Grössen auf Anfrage

01.006.xxx

Erlenmeyerkolben aus Borosilikatglas, DIN 12 387

Artikel-Nr.	Inhalt ml	NS			CHF / Stk.
01.006.001	10	14/23			
01.006.002	25	14/23			
01.006.003	50	14/23			
01.006.004	100	14/23			
01.006.005	25	19/26			
01.006.006	50	19/26			
01.006.007	100	19/26			
01.006.008	200	19/26			
01.006.009	250	19/26			
01.006.010	300	19/26			



AMSI-Glas AG

Glasapparate, Labor- u. Pilottechnik

Geismet 11, Postfach 22
CH-4317 Wegenstetten

Tel.: +41 61 873 90 93

Fax +41 61 873 90 94

www.amsi.ch

info@amsi.ch

01.006.xxx

Erlenmeyerkolben, Fortsetzung

Artikel-Nr.	Inhalt ml	NS			CHF / Stk.
01.006.011	50	24/29			
01.006.012	100	24/29			
01.006.013	200	24/29			
01.006.014	250	24/29			
01.006.015	300	24/29			
01.006.016	500	24/29			
01.006.017	1000	24/29			
01.006.018	2000	24/29			
01.006.019	50	29/32			
01.006.020	100	29/32			
01.006.021	200	29/32			
01.006.022	250	29/32			
01.006.023	300	29/32			
01.006.024	500	29/32			
01.006.025	1000	29/32			
01.006.026	2000	29/32			
01.006.027	200	45/40			
01.006.028	250	45/40			
01.006.029	300	45/40			
01.006.030	500	45/40			
01.006.031	1000	45/40			
01.006.032	2000	45/40			
01.006.033	5000	45/40			
01.006.034	1000	60/46			
01.006.035	2000	71/51			



Andere Grössen auf Anfrage

01.006.1xx

Erlenmeyerkolben aus Borosilikatglas, Braunglas

Artikel-Nr.	Inhalt ml	NS			CHF / Stk.
01.006.101	10	14/23			
01.006.102	25	14/23			
01.006.103	50	14/23			
01.006.104	100	14/23			
01.006.105	25	19/26			
01.006.106	50	19/26			
01.006.107	100	19/26			
01.006.108	200	19/26			
01.006.109	250	19/26			
01.006.110	300	19/26			



AMSI-Glas AG

Glasapparate, Labor- u. Pilottechnik

Geismet 11, Postfach 22
CH-4317 Wegenstetten

Tel.: +41 61 873 90 93

Fax +41 61 873 90 94

www.amsi.ch

info@amsi.ch

01.006.1xx

Erlenmeyerkolben, Braunglas, Fortsetzung

Artikel-Nr.	Inhalt ml	NS			CHF / Stk.
01.006.111	50	24/29			
01.006.112	100	24/29			
01.006.113	200	24/29			
01.006.114	250	24/29			
01.006.115	300	24/29			
01.006.116	500	24/29			
01.006.117	1000	24/29			
01.006.118	2000	24/29			
01.006.119	50	29/32			
01.006.120	100	29/32			
01.006.121	200	29/32			
01.006.122	250	29/32			
01.006.123	300	29/32			
01.006.124	500	29/32			
01.006.125	1000	29/32			
01.006.126	2000	29/32			
01.006.127	200	45/40			
01.006.128	250	45/40			
01.006.129	300	45/40			
01.006.130	500	45/40			
01.006.131	1000	45/40			
01.006.132	2000	45/40			
01.006.133	5000	45/40			
01.006.134	1000	60/46			
01.006.135	2000	71/51			

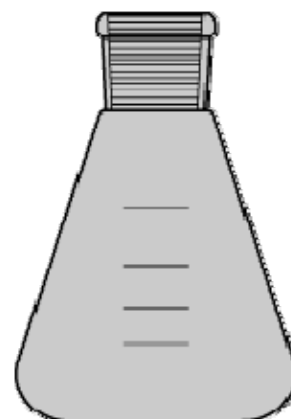

01.007.xxx

Erlenmeyerkolben aus Borosilikatglas

Mit Teilung, komplett mit roter Schraubverschlusskappe und PTFE-Dichtung

Artikel-Nr.	Inhalt ml	Gewinde GL			CHF / Stk.
01.007.001	25	25			
01.007.101	25	18			
01.007.002	50	25			
01.007.003	100	25			
01.007.004	250	32			
01.007.005	500	32			
01.007.006	1000	32			
01.007.007	2000	45			
01.007.008	3000	45			
01.007.009	5000	45			



AMSI-Glas AG

Glasapparate, Labor- u. Pilottechnik

Geismet 11, Postfach 22
CH-4317 Wegenstetten

Tel.: +41 61 873 90 93

Fax +41 61 873 90 94

www.amsi.ch

info@amsi.ch

01.009.xxx

Spitzkolben aus Borosilikatglas, mit schrägem Seitenhals

Artikel-Nr.	Inhalt ml	Mittelhals NS	Seitenhals NS		CHF / Stk.
01.009.001	10	14/23	14/23		
01.009.002	25	14/23	14/23		
01.009.003	50	14/23	14/23		
01.009.004	100	14/23	14/23		
01.009.005	10	19/26	14/23		
01.009.006	25	19/26	14/23		
01.009.007	50	19/26	14/23		
01.009.008	100	19/26	14/23		
01.009.009	250	19/26	14/23		
01.009.010	100	24/29	24/29		
01.009.011	250	24/29	24/29		
01.009.012	500	29/32	29/32		
01.009.013	1000	29/32	29/32		

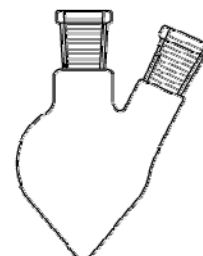

01.010.xxx

Rundkolben aus Borosilikatglas, mit schrägem Seitenhals

Artikel-Nr.	Inhalt ml	Mittelhals NS	Seitenhals NS		CHF / Stk.
01.010.001	25	14/23	14/23		
01.010.002	50	14/23	14/23		
01.010.003	100	14/23	14/23		
01.010.004	100	29/32	14/23		
01.010.005	250	29/32	14/23		
01.010.006	500	29/32	14/23		
01.010.007	1000	29/32	14/23		
01.010.008	2000	29/32	14/23		
01.010.009	250	29/32	29/32		
01.010.010	500	29/32	29/32		
01.010.011	1000	29/32	29/32		
01.010.012	2000	29/32	29/32		
01.010.013	5000	45/40	45/40		

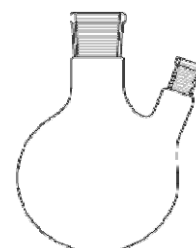

AMSI-Glas AG

Glasapparate, Labor- u. Pilottechnik

Geismet 11, Postfach 22
CH-4317 Wegenstetten

Tel.: +41 61 873 90 93

Fax +41 61 873 90 94

www.amsi.ch

info@amsi.ch

01.011.xxx

Rundkolben aus Borosilikatglas, mit geradem Seitenhals

Artikel-Nr.	Inhalt ml	Mittelhals NS	Seitenhals NS		CHF / Stk.
01.011.001	25	14/23	14/23		
01.011.002	50	14/23	14/23		
01.011.003	100	14/23	14/23		
01.011.004	100	29/32	14/23		
01.011.005	250	29/32	14/23		
01.011.006	500	29/32	14/23		
01.011.007	1000	29/32	14/23		
01.011.008	2000	29/32	14/23		
01.011.009	250	29/32	29/32		
01.011.010	500	29/32	29/32		
01.011.011	1000	29/32	29/32		
01.011.012	2000	29/32	29/32		

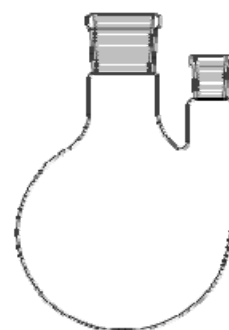

01.012.xxx

Dreihals-Rundkolben aus Borosilikatglas

Mit schrägen Seitenhälsen

Artikel-Nr.	Inhalt ml	Mittelhals NS	Seitenhäse NS		CHF / Stk.
01.012.001	25	14/23	14/23		
01.012.002	50	14/23	14/23		
01.012.003	100	14/23	14/23		
01.012.004	100	29/32	14/23		
01.012.005	250	29/32	14/23		
01.012.006	500	29/32	14/23		
01.012.007	1000	29/32	14/23		
01.012.008	2000	29/32	14/23		
01.012.009	4000	29/32	14/23		
01.012.010	6000	29/32	14/23		
01.012.011	250	29/32	29/32		
01.012.012	500	29/32	29/32		
01.012.013	1000	29/32	29/32		
01.012.014	2000	29/32	29/32		
01.012.015	4000	29/32	29/32		
01.012.016	6000	29/32	29/32		
01.012.017	10000	45/40	29/32		

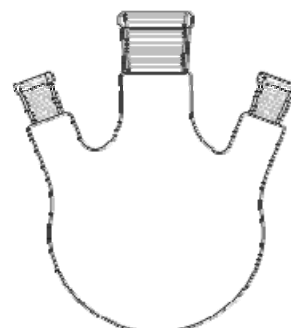

AMSI-Glas AG

Glasapparate, Labor- u. Pilottechnik

Geismet 11, Postfach 22
CH-4317 Wegenstetten

Tel.: +41 61 873 90 93

Fax +41 61 873 90 94

www.amsi.ch

info@amsi.ch

01.013.xxx

Dreihals-Rundkolben aus Borosilikatglas

Mit geraden Seitenhälsen

Artikel-Nr.	Inhalt ml	Mittelhals NS	Seitenhalse NS		CHF / Stk.
01.013.001	25	14/23	14/23		
01.013.002	50	14/23	14/23		
01.013.003	100	14/23	14/23		
01.013.004	100	29/32	14/23		
01.013.005	250	29/32	14/23		
01.013.006	500	29/32	14/23		
01.013.007	1000	29/32	14/23		
01.013.008	2000	29/32	14/23		
01.013.009	250	29/32	29/32		
01.013.010	500	29/32	29/32		
01.013.011	1000	29/32	29/32		
01.013.012	2000	29/32	29/32		
01.013.013	4000	29/32	29/32		
01.013.014	6000	29/32	29/32		
01.013.015	10000	45/40	29/32		

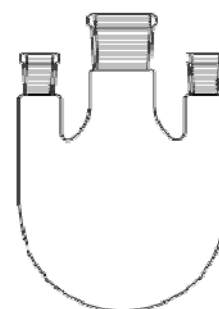

01.014.xxx

Rundkolben-Vorratsgefäß aus Borosilikatglas

Artikel-Nr.	Inhalt ml	Hülse NS	Kern NS		CHF / Stk.
01.014.001	100	29/32	29/32		
01.014.002	250	29/32	29/32		
01.014.003	500	29/32	29/32		
01.014.004	1000	29/32	29/32		
01.014.005	2000	29/32	29/32		
01.014.006	3000	45/40	29/32		
01.014.007	4000	45/40	29/32		
01.014.008	5000	45/40	29/32		



01.015.xxx

Vierhals-Rundkolben aus Borosilikatglas

Mit geraden Seitenhälsen

Artikel-Nr.	Inhalt ml	Mittelhals NS	Seitenhalse NS		CHF / Stk.
01.015.001	250	29/32	29/32		
01.015.002	500	29/32	29/32		



AMSI-Glas AG

Glasapparate, Labor- u. Pilottechnik

Geismet 11, Postfach 22
CH-4317 Wegenstetten

Tel.: +41 61 873 90 93

Fax +41 61 873 90 94

www.amsi.ch

info@amsi.ch

01.015.xxx

Vierhals-Rundkolben aus Borosilikatglas

Mit geraden Seitenhälsen

Fortsetzung

Artikel-Nr.	Inhalt ml	Mittelhals NS	Seitenhalse NS		CHF / Stk.
01.015.003	1000	29/32	29/32		
01.015.004	2000	29/32	29/32		
01.015.005	4000	29/32	29/32		
01.015.006	5000	29/32	29/32		
01.015.007	6000	29/32	29/32		
01.015.008	10000	45/40	29/32		



01.016.xxx

Normalschliff-Kerne aus Borosilikatglas

Artikel-Nr.	NS				CHF / Stk.
01.016.001	7/16				
01.016.002	10/19				
01.016.003	12/21				
01.016.004	14/23				
01.016.005	19/26				
01.016.006	24/29				
01.016.007	29/32				
01.016.008	34/35				
01.016.009	45/40				
01.016.010	60/46				
01.016.011	71/51				



01.017.xxx

Normalschliff-Hülsen aus Borosilikatglas

Artikel-Nr.	NS				CHF / Stk.
01.017.001	7/16				
01.017.002	10/19				
01.017.003	12/21				
01.017.004	14/23				
01.017.005	19/26				
01.017.006	24/29				
01.017.007	29/32				
01.017.008	34/35				
01.017.009	45/40				
01.017.010	60/46				
01.017.011	71/51				



AMSI-Glas AG

Glasapparate, Labor- u. Pilottechnik

Geismet 11, Postfach 22
CH-4317 Wegenstetten

Tel.: +41 61 873 90 93

Fax +41 61 873 90 94

www.amsi.ch

info@amsi.ch

01.018.xxx

Normalschliff-Kerne aus Borosilikatglas

Mit Verlängerung

Artikel-Nr.	NS				CHF / Stk.
01.018.001	7/16				
01.018.002	10/19				
01.018.003	12/21				
01.018.004	14/23				
01.018.005	19/26				
01.018.006	24/29				
01.018.007	29/32				
01.018.008	34/35				
01.018.009	45/40				
01.018.010	60/46				
01.018.011	71/51				



01.020.xxx

Kugelschliff-Kugeln aus Borosilikatglas

Artikel-Nr.	KS				CHF / Stk.
01.020.001	13/5				
01.020.002	19/9				
01.020.003	29/15				
01.020.004	35/20				
01.020.005	35/25				
01.020.006	40/25				
01.020.007	51/30				
01.020.008	65/40				



01.021.xxx

Kugelschliff-Pfannen aus Borosilikatglas

Artikel-Nr.	KS				CHF / Stk.
01.021.001	13/5				
01.021.002	19/9				
01.021.003	29/15				
01.021.004	35/20				
01.021.005	35/25				
01.021.006	40/25				
01.021.007	51/30				
01.021.008	65/40				



AMSI-Glas AG

Glasapparate, Labor- u. Pilottechnik

Geismet 11, Postfach 22
CH-4317 Wegenstetten

Tel.: +41 61 873 90 93

Fax +41 61 873 90 94

www.amsi.ch

info@amsi.ch

01.024.xxx

Gewinderohre aus Borosilikatglas, zum Ansetzen

DIN 12 216

Artikel-Nr.	Gewinde	Rohr-Ø mm	Wand mm	Länge mm	CHF / Stk.
01.024.001	GL 14	12	1.5	100	
01.024.002	GL 18	16	1.8	100	
01.024.003	GL 25	22	1.8	100	
01.024.004	GL 32	28	2	100	
01.024.005	GL 45	40	2.3	150	



01.024.1xx

Schlaucholiven aus Borosilikatglas, doppelseitig

Artikel-Nr.	Aussen-Ø	Länge mm			CHF / Stk.
01.024.101	6	115			
01.024.102	7	115			
01.024.103	8	115			
01.024.104	9	115			
01.024.105	10	115			
01.024.106	11	115			
01.024.107	12	115			

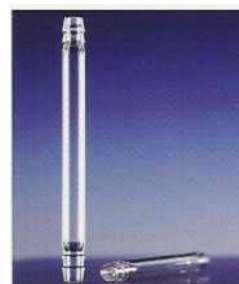

01.025.xxx

NS-Stopfen, hohl

Sechskantig, mit Abtropfspitze, aus Borosilikatglas

Artikel-Nr.	NS				CHF / Stk.
01.025.001	7/16				
01.025.002	10/19				
01.025.003	12/21				
01.025.004	14/23				
01.025.005	19/26				
01.025.006	24/29				
01.025.007	29/32				
01.025.008	34/35				
01.025.009	45/40				



Ausführung aus Braunglas - siehe 01.115.xxx

AMSI-Glas AG

Glasapparate, Labor- u. Pilottechnik

Geismet 11, Postfach 22
CH-4317 Wegenstetten

Tel.: +41 61 873 90 93

Fax +41 61 873 90 94

www.amsi.ch

info@amsi.ch

01.027.xxx

Reduzier-Übergangsstücke aus Borosilikatglas

Artikel-Nr.	NS-Kern	NS-Hülse			CHF / Stk.
01.027.001	19/26	14/23			
01.027.002	24/29	14/23			
01.027.003	29/32	14/23			
01.027.004	24/29	19/26			
01.027.005	29/32	19/26			
01.027.006	29/32	24/29			
01.027.007	45/40	29/32			
01.027.008	60/46	45/40			
01.027.009	71/51	45/40			

Andere Grössen auf Anfrage



01.028.xxx

Expansions-Übergangsstücke

Artikel-Nr.	NS-Kern	NS-Hülse			CHF / Stk.
01.028.001	14/23	19/26			
01.028.002	14/23	24/29			
01.028.003	14/23	29/32			
01.028.004	19/26	24/29			
01.028.005	19/26	29/32			
01.028.006	24/29	29/32			
01.028.007	29/32	34/35			
01.028.008	29/32	45/40			
01.028.009	45/40	60/46			
01.028.010	45/40	71/51			

Andere Grössen auf Anfrage



01.032.xxx

GL/NS-Übergangsstücke

GL-Gewinde auf NS-Kern

Artikel-Nr.	Gewinde GL	NS-Kern			CHF / Stk.
01.032.001	14	14/23			
01.032.002	14	19/26			
01.032.003	14	24/29			
01.032.004	14	29/32			
01.032.005	18	14/23			
01.032.006	18	19/26			
01.032.007	18	24/29			
01.032.008	18	29/32			



AMSI-Glas AG

Glasapparate, Labor- u. Pilottechnik

Geismet 11, Postfach 22
CH-4317 Wegenstetten

Tel.: +41 61 873 90 93

Fax +41 61 873 90 94

www.amsi.ch

info@amsi.ch

01.032.xxx

GL/NS-Übergangsstücke

Fortsetzung

Artikel-Nr.	Gewinde GL	NS-Kern			CHF / Stk.
01.032.009	25	19/26			
01.032.010	25	24/29			
01.032.011	25	29/32			
01.032.014	32	24/29			
01.032.015	32	29/32			



01.034.xxx

Verbindungsstücke mit NS und Olive

Ausführung gerade

Artikel-Nr.	NS-Kern	NS-Hülse			CHF / Stk.
01.034.001	14/23				
01.034.002	19/26				
01.034.003	24/29				
01.034.004	29/32				
01.034.005	34/35				
01.034.006	45/40				
01.034.007		14/23			
01.034.008		19/26			
01.034.009		24/29			
01.034.010		29/32			
01.034.011		34/35			
01.034.012		45/40			



01.035.xxx

Verbindungsstücke mit NS und Olive

Ausführung gebogen

Artikel-Nr.	NS-Kern	NS-Hülse			CHF / Stk.
01.035.001	14/23				
01.035.002	19/26				
01.035.003	24/29				
01.035.004	29/32				
01.035.005	34/35				
01.035.006	45/40				
01.035.007		14/23			
01.035.008		19/26			
01.035.009		24/29			
01.035.010		29/32			
01.035.011		34/35			
01.035.012		45/40			



AMSI-Glas AG

Glasapparate, Labor- u. Pilottechnik

Geismet 11, Postfach 22
CH-4317 Wegenstetten

Tel.: +41 61 873 90 93

Fax +41 61 873 90 94

www.amsi.ch

info@amsi.ch

01.036.xxx

Verbindungsstücke mit NS und Hahn

Glashahn, Ausführung **gerade**

Artikel-Nr.	NS-Kern	NS-Hülse			CHF / Stk.
01.036.001	14/23				
01.036.002	19/26				
01.036.003	24/29				
01.036.004	29/32				
01.036.005	34/35				
01.036.006	45/40				
01.036.007		14/23			
01.036.008		19/26			
01.036.009		24/29			
01.036.010		29/32			
01.036.011		34/35			
01.036.012		45/40			



01.038.xxx

Verbindungsstücke mit NS und Hahn

Glashahn 2,5 mm, Ausführung **gebogen**

Artikel-Nr.	NS-Kern	NS-Hülse			CHF / Stk.
01.038.001	14/23				
01.038.002	19/26				
01.038.003	24/29				
01.038.004	29/32				
01.038.005	34/35				
01.038.006	45/40				
01.038.007		14/23			
01.038.008		19/26			
01.038.009		24/29			
01.038.010		29/32			
01.038.011		34/35			
01.038.012		45/40			



AMSI-Glas AG

Glasapparate, Labor- u. Pilottechnik

Geismet 11, Postfach 22
CH-4317 Wegenstetten

Tel.: +41 61 873 90 93

Fax +41 61 873 90 94

www.amsi.ch

info@amsi.ch

01.041.xxx

Siedekapillare

Artikel-Nr.	NS-Kern	ab Oberkante NS - Länge mm		CHF / Stk.
01.041.001	14/23	200		
01.041.002	19/26	200		
01.041.003	29/32	200		



01.042.xxx

Einleitungsrohre

Mit abgebogener Olive

Artikel-Nr.	NS-Kern	Einbaulänge mm		CHF / Stk.
01.042.001	14/23	200		
01.042.002	19/26	200		
01.042.003	24/29	200		
01.042.004	29/32	200		



01.043.xxx

Einleitungsrohre

Mit seitlichem Spindelhahn 0-3 mm und Olive Adm. Ø 8 mm

Artikel-Nr.	NS-Kern	Einbaulänge mm		CHF / Stk.
01.043.001	14/23	200		
01.043.002	19/26	200		
01.043.003	29/32	200		



01.044.xxx

Trockenrohre (Chlorcalciumrohre)

Artikel-Nr.	NS-Kern				CHF / Stk.
01.044.001	14/23				
01.044.002	19/26				
01.044.003	24/29				
01.044.004	29/32				



AMSI-Glas AG

Glasapparate, Labor- u. Pilottechnik

Geismet 11, Postfach 22
CH-4317 Wegenstetten

Tel.: +41 61 873 90 93
Fax +41 61 873 90 94
www.amsi.ch
info@amsi.ch

01.050.xxx

Vakuum-Vorstösse, gerade

Mit Abtropfspitze, Saugrohr mit Olive 10 mm

Artikel-Nr.	NS-Hülse	NS-Kern			CHF / Stk.
01.050.001	14/23	14/23			
01.050.002	19/26	19/26			
01.050.003	29/32	29/32			



01.051.xxx

Vakuum-Vorstösse, gebogen

Mit Abtropfspitze, Saugrohr mit Olive 10 mm

Artikel-Nr.	NS-Hülse	NS-Kern			CHF / Stk.
01.051.001	14/23	14/23			
01.051.002	19/26	19/26			
01.051.003	29/32	29/32			



01.052.xxx

Destilliervorlagen nach Bredt

Mit schrägem Vorstoss

Artikel-Nr.	NS-Hülse seitlich	NS-Hülse unten			CHF / Stk.
01.052.001	14/23	19/26			
01.052.002	29/32	29/32			

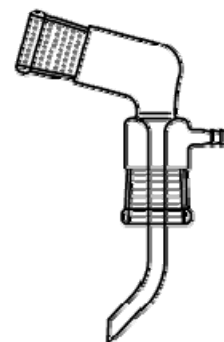

01.053.xxx

Verteiler (Spinne)

Artikel-Nr.	1 NS-Kern	4 NS-Kerne	für Kolben		CHF / Stk.
01.053.001	19/26	14/23	50 ml		
01.053.002	29/32	14/23	100 ml		

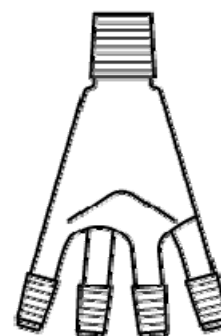

AMSI-Glas AG

Glasapparate, Labor- u. Pilottechnik

Geismet 11, Postfach 22
CH-4317 Wegenstetten

Tel.: +41 61 873 90 93

Fax +41 61 873 90 94

www.amsi.ch

info@amsi.ch

01.054.xxx

Destilliervorlagen nach Bernauer

Mit Absaugrohr, ohne Rundkolben

Artikel-Nr.	1 NS-Hülse	3 NS-Kerne	für Rundkolben	CHF / Stk.
01.054.001	14/23	14/23	50 ml	
01.054.002	29/32	14/23	100 ml	

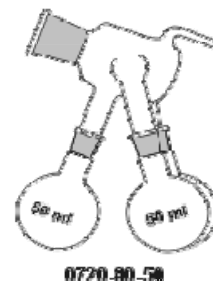

01.065.xxx

Destillier-Aufsätze

Mit NS-Hülse und 2 NS-Kerne im Winkel von 75°, für Thermometer 55 mm EBL

Artikel-Nr.	NS-Hülse	NS-Kern (Kolben)	NS-Kern (Kühler)	CHF / Stk.
01.065.001	14/23	14/23	14/23	
01.065.002	14/23	29/32	29/32	
01.065.003	29/32	29/32	29/32	



01.066.xxx

Destillier-Aufsätze nach Claisen

Mit 2 NS-Hülsen parallel und 2 NS-Kerne im Winkel von 75°

Artikel-Nr.	2 NS-Hülsen	NS-Kern (Kolben)	NS-Kern (Kühler)	CHF / Stk.
01.066.001	14/23	14/23	14/23	
01.066.002	14/23	29/32	29/32	
01.066.003	29/32	29/32	29/32	



01.067.xxx

Tropfenfänger nach Stutzer

Artikel-Nr.	NS-Kern	NS-Hülse	CHF / Stk.
01.067.001	14/23	14/23	
01.067.002	19/26	19/26	
01.067.003	29/32	29/32	



AMSI-Glas AG

Glasapparate, Labor- u. Pilottechnik

Geismet 11, Postfach 22
CH-4317 Wegenstetten

Tel.: +41 61 873 90 93
Fax +41 61 873 90 94
www.amsi.ch
info@amsi.ch

01.071.xxx

Destillierbrücken

Mit zwei senkrechten Kernen

Artikel-Nr.	NS-Kerne	Länge mm			CHF / Stk.
01.071.001	14/23	300			
01.071.002	29/32	300			



01.072.xxx

Destillierbrücken

Mit Tropfenfänger nach Stutzer, zwei senkrechte Kerne, Kugel ca. 60 mm Ø

Artikel-Nr.	NS-Kerne	Länge mm			CHF / Stk.
01.072.001	14/23	200			
01.072.002	19/26	200			
01.072.003	29/32	200			

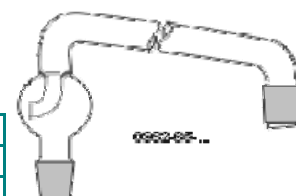

01.074.xxx

Destillierbrücken

Mit zwei senkrechten NS-Kernen und NS-Hülse

Artikel-Nr.	NS-Hülse	2 NS-Kerne	Länge mm		CHF / Stk.
01.074.001	14/23	14/23	300		
01.074.002	14/23	29/32	300		



01.075.xxx

Destillierbrücken

Mit NS-Hülse 14/23, angeschmolzenem Liebigkühler

Artikel-Nr.	NS-Kern (Kolben)	NS-Kern (Kühler)	Mantellänge mm		CHF / Stk.
01.075.101	14/23	14/23	100		
01.075.001	14/23	14/23	160		
01.075.002	14/23	14/23	200		
01.075.003	14/23	14/23	300		
01.075.004	29/32	29/32	200		
01.075.005	29/32	29/32	250		
01.075.006	29/32	29/32	300		
01.075.007	29/32	29/32	400		
01.075.008	29/32	29/32	500		



AMSI-Glas AG

Glasapparate, Labor- u. Pilottechnik

Geismet 11, Postfach 22
CH-4317 Wegenstetten

Tel.: +41 61 873 90 93

Fax +41 61 873 90 94

www.amsi.ch

info@amsi.ch

01.076.xxx

Destillierbrücken

Mit NS-Hülse 14/23, angeschmolzenem Liebigkühler, NS-Kern senkrecht und Absaugstutzen am Ablaufrohr

Artikel-Nr.	NS-Kern (Kolben)	NS-Kern (Kühler)	Mantellänge mm		CHF / Stk.
01.076.001	14/23	14/23	160		
01.076.002	14/23	14/23	200		
01.076.003	14/23	14/23	300		
01.076.004	29/32	29/32	100		
01.076.005	29/32	29/32	200		
01.076.006	29/32	29/32	250		
01.076.007	29/32	29/32	300		
01.076.008	29/32	29/32	400		
01.076.009	29/32	29/32	500		



01.077.xxx

Destillierbrücken nach Claisen

Mit 2 NS-Hülsen 14/23, angeschmolzenem Liebigkühler, mit Saugstutzen

Artikel-Nr.	NS-Kern (Kolben)	NS-Kern (Kühler)	Mantellänge mm		CHF / Stk.
01.077.001	14/23	14/23	160		
01.077.002	14/23	14/23	200		
01.077.003	14/23	14/23	300		
01.077.004	29/32	29/32	200		
01.077.005	29/32	29/32	250		
01.077.006	29/32	29/32	300		
01.077.007	29/32	29/32	400		
01.077.008	29/32	29/32	500		



AMSI-Glas AG

Glasapparate, Labor- u. Pilottechnik

Geismet 11, Postfach 22
CH-4317 Wegenstetten

Tel.: +41 61 873 90 93

Fax +41 61 873 90 94

www.amsi.ch

info@amsi.ch

01.080.xxx

Liebigkühler, Wasseranschlüsse mit Oliven \varnothing 10 mm

Artikel-Nr.	NS-Kern	NS-Hülse	Mantellänge mm	CHF / Stk.
01.080.001	14/23	14/23	160	
01.080.002	14/23	14/23	200	
01.080.003	14/23	14/23	300	
01.080.004	14/23	14/23	400	
01.080.005	29/32	29/32	200	
01.080.006	29/32	29/32	250	
01.080.007	29/32	29/32	300	
01.080.008	29/32	29/32	400	
01.080.009	29/32	29/32	500	
01.080.010	29/32	29/32	600	



01.081.xxx

Kugelkühler nach Allihn, Wasseranschlüsse mit Oliven \varnothing 10 mm

DIN 12 581

Artikel-Nr.	NS-Kern	NS-Hülse	Mantellänge mm	CHF / Stk.
01.081.001	14/23	14/23	200	
01.081.002	14/23	14/23	300	
01.081.003	14/23	14/23	400	
01.081.004	29/32	29/32	200	
01.081.005	29/32	29/32	300	
01.081.006	29/32	29/32	400	
01.081.007	29/32	29/32	500	



01.084.xxx

Dimrothkühler, Wasseranschlüsse mit Oliven \varnothing 10 mm

DIN 12 591

Artikel-Nr.	NS-Kern	NS-Hülse	Mantellänge mm	CHF / Stk.
01.084.001	14/23	14/23	160	
01.084.002	14/23	14/23	200	
01.084.003	14/23	14/23	300	
01.084.004	29/32	29/32	200	
01.084.005	29/32	29/32	250	
01.084.006	29/32	29/32	300	
01.084.007	29/32	29/32	400	



AMSI-Glas AG

Glasapparate, Labor- u. Pilottechnik

Geismet 11, Postfach 22
CH-4317 Wegenstetten

Tel.: +41 61 873 90 93

Fax +41 61 873 90 94

www.amsi.ch

info@amsi.ch

01.086.xxx

Intensivkühler, doppelwandig

DIN 12 593

Wasseranschlüsse mit Oliven \varnothing 10 mm				
Artikel-Nr.	NS-Kern	NS-Hülse	Mantellänge mm	CHF / Stk.
01.086.001	14/23	14/23	200	
01.086.002	29/32	29/32	200	
01.086.003	29/32	29/32	250	
01.086.004	29/32	29/32	300	
01.086.005	29/32	29/32	400	
Mit Gewinde GL 14				
01.086.006	14/23	14/23	200	
01.086.007	29/32	29/32	200	
01.086.008	29/32	29/32	300	
01.086.009	29/32	29/32	400	



Andere Grössen auf Anfrage

01.088.xxx

Schlangenkühler, Wasseranschlüsse mit Oliven \varnothing 10 mm

Artikel-Nr.	NS-Kern	NS-Hülse	Mantellänge mm	CHF / Stk.
01.088.001	14/23	14/23	160	
01.088.002	14/23	14/23	200	
01.088.003	29/32	29/32	200	
01.088.004	29/32	29/32	300	
01.088.005	29/32	29/32	400	
01.088.006	29/32	29/32	500	



01.089.xxx

Kühlrohr (Luftkühler)

Artikel-Nr.	NS-Kern	Nutzlänge mm	CHF / Stk.
01.089.001	29/32	250	
01.089.002	29/32	350	
01.089.003	29/32	500	
01.089.004	29/32	600	
01.089.005	29/32	750	
01.089.006	29/32	1000	



AMSI-Glas AG

Glasapparate, Labor- u. Pilottechnik

Geismet 11, Postfach 22
CH-4317 Wegenstetten

Tel.: +41 61 873 90 93
Fax +41 61 873 90 94
www.amsi.ch
info@amsi.ch

01.090.xxx

Hempel-Kolonnen

Mit Füllkörperträger, ohne Mantel

Artikel-Nr.	NS	Idm. mm	Nutzlänge mm	CHF / Stk.
01.090.001	14/23	15	200	
01.090.002	14/23	15	300	
01.090.003	29/32	30	300	
01.090.004	29/32	30	400	
01.090.005	29/32	30	500	
01.090.006	24/29	30	500	



01.091.xxx

Hempel-Kolonnen

Mit Vakuummantel und Füllkörperträger

Artikel-Nr.	NS	Idm. mm	Nutzlänge mm	CHF / Stk.
01.091.001	14/23	15	200	
01.091.002	14/23	15	300	
01.091.003	29/32	30	300	
01.091.004	29/32	30	400	
01.091.005	29/32	30	500	
01.091.006	24/29	30	500	



1184-...

Glasperlen und Raschigringe auf Anfrage

01.092.xxx

Vigreux-Kolonnen (Fraktionierkolonne)

Artikel-Nr.	NS	Idm. mm	Nutzlänge mm	CHF / Stk.
01.092.001	14/23	15	200	
01.092.002	14/23	15	300	
01.092.003	24/29	21	300	
01.092.004	29/32	25	300	
01.092.005	29/32	25	600	
01.092.006	29/32	25	800	



Andere Grössen auf Anfrage

AMSI-Glas AG

Glasapparate, Labor- u. Pilottechnik

Geismet 11, Postfach 22
CH-4317 Wegenstetten

Tel.: +41 61 873 90 93
Fax +41 61 873 90 94
www.amsi.ch
info@amsi.ch

01.093.xxx

Vigreux-Kolonnen

Mit Vakuummantel

Artikel-Nr.	NS	Idm. mm	Nutzlänge mm	CHF / Stk.
01.093.001	14/23	15	200	
01.093.002	14/23	15	300	
01.093.003	29/32	25	300	
01.093.004	29/32	25	600	



01.100.xxx

Destilliervorlage nach Anschütz-Thiele

Mit Glashähne, gerade, graduiert

Artikel-Nr.	Inhalt ml	NS-Kern	NS-Hülse	CHF / Stk.
01.100.001	25	14/23	14/23	
01.100.002	50	29/32	29/32	
01.100.003	100	29/32	29/32	



01.102.xxx

Destilliervorlage nach Anschütz-Thiele

Mit Glashähne, gebogen, graduiert

Artikel-Nr.	Inhalt ml	NS-Kern	NS-Hülse	CHF / Stk.
01.102.001	25	14/23	14/23	
01.102.002	50	29/32	29/32	
01.102.003	100	29/32	29/32	



01.106.xxx

Kolonnenkopf mit Intensivkühler

Mit Ventilhahn zur genauen Rücklaufeinstellung mit PTFE-Absperrhahn; Kolonnenstützen mit NS 29/32, zwei Vakuumhähne, NS-Hülse 14/23 für Thermometer mit 60 mm Einbaulänge

Artikel-Nr.	NS-Kerne	Hähne	CHF / Stk.
01.106.001	14/23	PTFE	
01.106.002	29/32	PTFE	
01.106.003	14/23	Glas	
01.106.004	29/32	Glas	

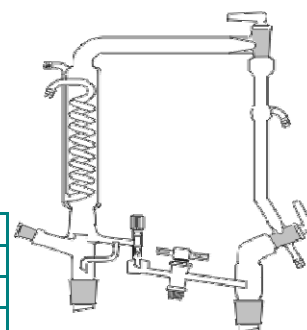

AMSI-Glas AG

Glasapparate, Labor- u. Pilottechnik

Geismet 11, Postfach 22
CH-4317 Wegenstetten

Tel.: +41 61 873 90 93

Fax +41 61 873 90 94

www.amsi.ch

info@amsi.ch

01.110.xxx

Kühlfinger (Einhängekühler)

Aus Borosilikatglas, Oliven 10 mm

Artikel-Nr.	NS	Ø x Einbaulänge mm		CHF / Stk.
01.110.001	14/23	10 x 100		
01.110.002	19/26	15 x 200		
01.110.003	29/32	24 x 300		



01.111.xxx

Absorptionsgefäß für Cyanid und Königswasser

Aus Borosilikatglas, DIN 38 405

Artikel-Nr.	NS-Kern	Masse mm	Inhalt ca.		CHF / Stk.
01.111.001	29/32	Ø 30 mm	30 ml		
01.111.002	29/32	Ø 40 mm	50 ml		



1015-...

01.115.xxx

NS-Stopfen, Braunglas

Sechskant, mit Abtropfspitze, aus Borosilikatglas

Artikel-Nr.	NS				CHF / Stk.
01.115.001	7/16				
01.115.002	10/19				
01.115.003	12/21				
01.115.004	14/23				
01.115.005	19/26				
01.115.006	24/29				
01.115.007	29/32				
01.115.008	34/35				
01.115.009	45/40				
01.115.010	60/46				

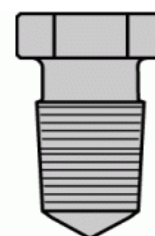

AMSI-Glas AG

Glasapparate, Labor- u. Pilottechnik

Geismet 11, Postfach 22
CH-4317 Wegenstetten

Tel.: +41 61 873 90 93

Fax +41 61 873 90 94

www.amsi.ch

info@amsi.ch

01.119.xxx

Wägegäser aus Borosilikatglas, hohe Form

Mit Pressdeckel

Artikel-Nr.	Höhe mm	Adm. mm	NS		CHF / Stk.
01.119.001	30	15 (18)	14/12		
01.119.002	40	25 (28)	24/12		
01.119.003	40	30 (32)	29/12		
01.119.004	50	30 (32)	29/12		
01.119.005	50	40 (44)	40/12		
01.119.006	60	30 (34)	29/12		
01.119.007	60	50 (54)	50/12		
01.119.008	70	35 (38)	34/12		
01.119.009	80	50 (54)	50/12		
01.119.010	80	40 (44)	40/12		
01.119.011	100	40 (44)	40/12		

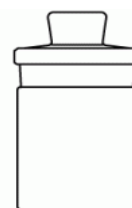

01.120.xxx

Wägegäser aus Borosilikatglas, niedere Form

Mit Pressdeckel

Artikel-Nr.	Höhe mm	Adm. mm	NS		CHF / Stk.
01.120.001	20	20 (24)	19/12		
01.120.002	25	25 (28)	24/12		
01.120.003	25	40 (44)	40/12		
01.120.004	30	30 (34)	29/12		
01.120.005	30	35 (38)	34/12		
01.120.006	30	50 (54)	50/12		
01.120.007	30	80 (85)	80/12		
01.120.008	40	40 (44)	40/12		
01.120.009	40	80 (85)	80/12		
01.120.010	60	60 (65)	60/12		
01.120.011	40	100 (105)	100/12		

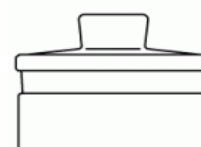

01.130.xxx

Scheidetrichter, ISO

Konische Form, ohne Teilung, mit Glasreiber

Artikel-Nr.	Inhalt ml	NS-Hülse	Bohrung mm		CHF / Stk.
01.130.001	50	19/26	12/2.5		
01.130.002	100	19/26	14/2.5		
01.130.003	250	29/32	14/4		
01.130.004	500	29/32	19/4		
01.130.005	1000	29/32	19/6		
01.130.006	2000	29/32	21/6		



AMSI-Glas AG

Glasapparate, Labor- u. Pilottechnik

Geismet 11, Postfach 22
CH-4317 Wegenstetten

Tel.: +41 61 873 90 93

Fax +41 61 873 90 94

www.amsi.ch

info@amsi.ch

01.131.xxx

Scheidetrichter, ISO

Konische Form, ohne Teilung, mit PTFE-Reiber

Artikel-Nr.	Inhalt ml	NS-Hülse	Bohrung mm		CHF / Stk.
01.131.001	50	19/26	12/2.5		
01.131.002	100	19/26	14/2.5		
01.131.003	250	29/32	14/4		
01.131.004	500	29/32	19/4		
01.131.005	1000	29/32	19/6		
01.131.006	2000	29/32	21/6		



01.134.xxx

Scheidetrichter, ISO

Konische Form, mit Glasreiber, graduiert

Artikel-Nr.	Inhalt ml	NS-Hülse	Bohrung mm		CHF / Stk.
01.134.001	50	19/26	12/2.5		
01.134.002	100	19/26	14/2.5		
01.134.003	250	29/32	14/4		
01.134.004	500	29/32	19/4		
01.134.005	1000	29/32	19/6		
01.134.006	2000	29/32	21/6		



01.135.xxx

Scheidetrichter, ISO

Konische Form, mit PTFE-Reiber, graduiert

Artikel-Nr.	Inhalt ml	NS-Hülse	Bohrung mm		CHF / Stk.
01.135.001	50	19/26	12/2.5		
01.135.002	100	19/26	14/2.5		
01.135.003	250	29/32	14/4		
01.135.004	500	29/32	19/4		
01.135.005	1000	29/32	19/6		
01.135.006	2000	29/32	21/6		



AMSI-Glas AG

Glasapparate, Labor- u. Pilottechnik

Geismet 11, Postfach 22
CH-4317 Wegenstetten

Tel.: +41 61 873 90 93
Fax +41 61 873 90 94
www.amsi.ch
info@amsi.ch

01.136.xxx

Scheidetrichter, Squibb

Konische Form, ohne Teilung, mit **Glasreiber**

Artikel-Nr.	Inhalt ml	NS-Hülse	Bohrung mm		CHF / Stk.
01.136.001	25	14/23	12/1.5		
01.136.002	50	19/26	12/2.5		
01.136.003	100	19/26	14/2.5		
01.136.004	250	19/26	14/4		
01.136.005	250	29/32	19/4		
01.136.006	500	29/32	19/4		
01.136.007	1000	29/32	19/6		
01.136.008	2000	29/32	19/6		



01.137.xxx

Scheidetrichter, Squibb

Konische Form, ohne Teilung, mit **PTFE-Reiber**

Artikel-Nr.	Inhalt ml	NS-Hülse	Bohrung mm		CHF / Stk.
01.137.001	25	14/23	12/1.5		
01.137.002	50	19/26	12/2.5		
01.137.003	100	19/26	14/2.5		
01.137.004	250	19/26	14/4		
01.137.005	250	29/32	19/4		
01.137.006	500	29/32	19/4		
01.137.007	1000	29/32	19/6		
01.137.008	2000	29/32	19/6		



01.140.xxx

Scheidetrichter, Squibb

Konische Form, mit **Glasreiber**. graduiert

Artikel-Nr.	Inhalt ml	NS-Hülse	Bohrung mm		CHF / Stk.
01.140.001	25	14/23	12/1.5		
01.140.002	50	19/26	14/2.5		
01.140.003	100	19/26	14/2.5		
01.140.004	250	19/26	14/4		
01.140.005	250	29/32	19/4		
01.140.006	500	29/32	19/4		
01.140.007	1000	29/32	19/6		
01.140.008	2000	29/32	19/6		

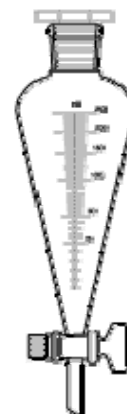

Andere Grössen auf Anfrage

AMSI-Glas AG

Glasapparate, Labor- u. Pilottechnik

Geismet 11, Postfach 22
CH-4317 Wegenstetten

Tel.: +41 61 873 90 93
Fax +41 61 873 90 94
www.amsi.ch
info@amsi.ch

01.141.xxx

Scheidetrichter, Squibb

Konische Form, mit **PTFE-Reiber**, graduiert

Artikel-Nr.	Inhalt ml	NS-Hülse	Bohrung mm		CHF / Stk.
01.141.001	25	14/23	12/1.5		
01.141.002	50	19/26	12/2.5		
01.141.003	100	19/26	14/2.5		
01.141.004	250	19/26	14/4		
01.141.005	250	29/32	19/4		
01.141.006	500	29/32	19/4		
01.141.007	1000	29/32	19/6		
01.141.008	2000	29/32	19/6		

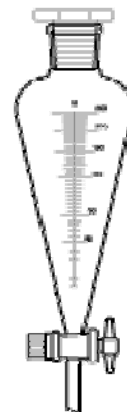

01.141.1xx

Scheidetrichter, Squibb

Konische Form, mit **Spindelhahn**, graduiert

Artikel-Nr.	Inhalt ml	NS-Hülse	Bohrung mm		CHF / Stk.
01.141.101	50	19/26	0-3		
01.141.102	100	19/26	0-3		
01.141.103	250	19/26	0-3		
01.141.104	250	29/32	0-3		
01.141.105	500	29/32	0-6		
01.141.106	1000	29/32	0-6		
01.141.107	2000	29/32	0-6		

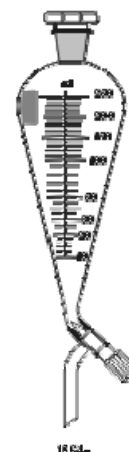

01.142.xxx

Scheidetrichter

Zylindrische Form, ohne Teilung, mit **Glasreiber**

Artikel-Nr.	Inhalt ml	NS-Hülse	Bohrung mm		CHF / Stk.
01.142.001	50	19/26	14/2.5		
01.142.002	100	19/26	14/2.5		
01.142.003	250	29/32	19/4		
01.142.004	500	29/32	19/4		
01.142.005	1000	29/32	19/6		
01.142.006	2000	29/32	19/6		

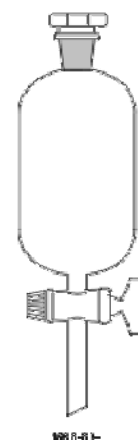

Andere Grössen auf Anfrage

AMSI-Glas AG

Glasapparate, Labor- u. Pilottechnik

Geismet 11, Postfach 22
CH-4317 Wegenstetten

Tel.: +41 61 873 90 93

Fax +41 61 873 90 94

www.amsi.ch

info@amsi.ch

01.143.xxx

Scheidetrichter

Zylindrische Form, ohne Teilung, mit **PTFE-Reiber**

Artikel-Nr.	Inhalt ml	NS-Hülse	Bohrung mm		CHF / Stk.
01.143.001	50	19/26	14/2.5		
01.143.002	100	19/26	14/2.5		
01.143.003	250	29/32	19/4		
01.143.004	500	29/32	19/4		
01.143.005	1000	29/32	19/6		
01.143.006	2000	29/32	19/6		



01.144.xxx

Scheidetrichter

Zylindrische Form, mit **Glasreiber**, graduiert

Artikel-Nr.	Inhalt ml	NS-Hülse	Bohrung mm		CHF / Stk.
01.144.001	50	19/26	14/2.5		
01.144.002	100	19/26	14/2.5		
01.144.003	250	29/32	19/4		
01.144.004	500	29/32	19/4		
01.144.005	1000	29/32	19/6		
01.144.006	2000	29/32	19/6		
01.144.007	3000	29/32	21/8		

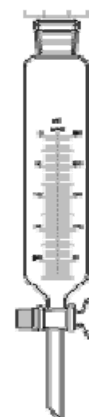

01.145.xxx

Scheidetrichter

Zylindrische Form, mit **PTFE-Reiber**, graduiert

Artikel-Nr.	Inhalt ml	NS-Hülse	Bohrung mm		CHF / Stk.
01.145.001	50	19/26	14/2.5		
01.145.002	100	19/26	14/2.5		
01.145.003	250	29/32	19/4		
01.145.004	500	29/32	19/4		
01.145.005	1000	29/32	19/6		
01.145.006	2000	29/32	19/6		
01.145.007	3000	29/32	21/8		

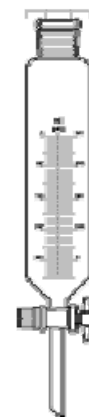

Andere Grössen auf Anfrage

AMSI-Glas AG

Glasapparate, Labor- u. Pilottechnik

Geismet 11, Postfach 22
CH-4317 Wegenstetten

Tel.: +41 61 873 90 93
Fax +41 61 873 90 94
www.amsi.ch
info@amsi.ch

01.146.xxx

Scheidetrichter

Zylindrische Form, mit PTFE-Spindelhahn, ohne Teilung

Artikel-Nr.	Inhalt ml	NS	Bohrung mm		CHF / Stk.
01.146.001	50	19/26	0-3		
01.146.002	100	19/26	0-3		
01.146.003	250	29/32	0-3		
01.146.004	500	29/32	0-6		
01.146.005	1000	29/32	0-6		
01.146.006	2000	29/32	0-6		



01.147.xxx

Scheidetrichter

Zylindrische Form, mit PTFE-Spindelhahn, graduiert

Artikel-Nr.	Inhalt ml	NS	Bohrung mm		CHF / Stk.
01.147.001	50	19/26	0-3		
01.147.002	100	19/26	0-3		
01.147.003	250	29/32	0-3		
01.147.004	500	29/32	0-6		
01.147.005	1000	29/32	0-6		
01.147.006	2000	29/32	0-6		

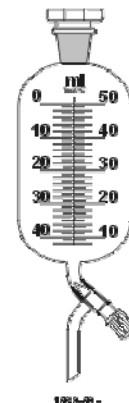

01.148.xxx

Tropftrichter, graduiert

Zylindrische Form, NS-Hülse und Kern, eingeschmolzene Tropfspitze, mit Glasreiber

Artikel-Nr.	Inhalt ml	NS	Bohrung mm		CHF / Stk.
01.148.001	25	14/23	12/1.5		
01.148.002	50	14/23	14/2.5		
01.148.003	100	14/23	14/2.5		
01.148.004	250	14/23	14/4		
01.148.005	50	19/26	14/2.5		
01.148.006	100	19/26	14/2.5		
01.148.007	50	29/32	14/2.5		
01.148.008	100	29/32	14/2.5		
01.148.009	250	29/32	19/4		
01.148.010	500	29/32	19/4		
01.148.011	1000	29/32	19/6		
01.148.012	2000	29/32	21/6		



Andere Grössen auf Anfrage

AMSI-Glas AG

Glasapparate, Labor- u. Pilottechnik

Geismet 11, Postfach 22
CH-4317 Wegenstetten

Tel.: +41 61 873 90 93

Fax +41 61 873 90 94

www.amsi.ch

info@amsi.ch

01.149.xxx

Tropftrichter, graduiert

Zylindrische Form, NS-Hülse und Kern, eingeschmolzene Tropfspitze, mit **PTFE-Reiber**

Artikel-Nr.	Inhalt ml	NS	Bohrung mm		CHF / Stk.
01.149.001	25	14/23	12/1.5		
01.149.002	50	14/23	14/2.5		
01.149.003	100	14/23	14/2.5		
01.149.004	250	14/23	14/4		
01.149.005	50	19/26	14/2.5		
01.149.006	100	19/26	14/2.5		
01.149.007	50	29/32	14/2.5		
01.149.008	100	29/32	14/2.5		
01.149.009	250	29/32	19/4		
01.149.010	500	29/32	19/4		
01.149.011	1000	29/32	19/6		
01.149.012	2000	29/32	21/6		

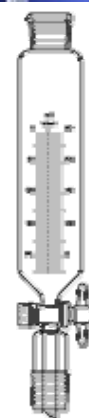

01.152.xxx

Tropftrichter, graduiert

Zylindrische Form, NS-Hülse und Kern, eingeschmolzene Tropfspitze und Druckausgleich, mit **Glasreiber**

Artikel-Nr.	Inhalt ml	NS	Bohrung mm		CHF / Stk.
01.152.001	25	14/23	12/1.5		
01.152.002	50	14/23	14/2.5		
01.152.003	100	14/23	14/2.5		
01.152.004	250	14/23	14/4		
01.152.005	50	19/26	14/2.5		
01.152.006	100	19/26	14/2.5		
01.152.007	50	29/32	14/2.5		
01.152.008	100	29/32	14/2.5		
01.152.009	250	29/32	19/4		
01.152.010	500	29/32	19/4		
01.152.011	1000	29/32	19/6		
01.152.012	2000	29/32	21/6		

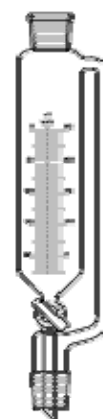

Andere Grössen auf Anfrage

AMSI-Glas AG

Glasapparate, Labor- u. Pilottechnik

Geismet 11, Postfach 22
CH-4317 Wegenstetten

Tel.: +41 61 873 90 93

Fax +41 61 873 90 94

www.amsi.ch

info@amsi.ch

01.153.xxx

Tropftrichter, graduiert

Zylindrische Form, NS-Hülse und Kern, eingeschmolzene Tropfspitze und Druckausgleich, mit **PTFE-Reiber**

Artikel-Nr.	Inhalt ml	NS	Bohrung mm		CHF / Stk.
01.153.001	25	14/23	12/1.5		
01.153.002	50	14/23	14/2.5		
01.153.003	100	14/23	14/2.5		
01.153.004	250	14/23	14/4		
01.153.005	50	19/26	14/2.5		
01.153.006	100	19/26	14/2.5		
01.153.007	50	29/32	14/2.5		
01.153.008	100	29/32	14/2.5		
01.153.009	250	29/32	19/4		
01.153.010	500	29/32	19/4		
01.153.011	1000	29/32	19/6		
01.153.012	2000	29/32	21/6		

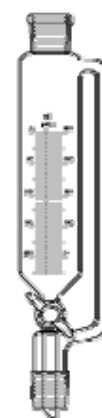

01.154.xxx

Tropftrichter, graduiert

Zylindrische Form, NS-Hülse und Kern, eingeschmolzene Tropfspitze und Druckausgleich, mit **PTFE-Spindelhahn**

Artikel-Nr.	Inhalt ml	NS	Hahn mm		CHF / Stk.
01.154.001	50	14/23	0-2,5		
01.154.002	100	14/23	0-2,5		
01.154.003	50	19/26	0-2,5		
01.154.004	100	19/26	0-2,5		
01.154.005	100	29/32	0-2,5		
01.154.006	250	29/32	0-4		
01.154.007	500	29/32	0-6		
01.154.008	1000	29/32	0-6		
01.154.009	2000	29/32	0-6		
01.154.010	3000	29/32	0-10		

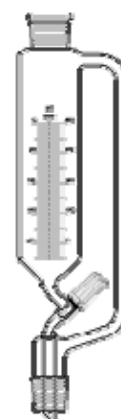

Andere Grössen auf Anfrage

AMSI-Glas AG

Glasapparate, Labor- u. Pilottechnik

Geismet 11, Postfach 22
CH-4317 Wegenstetten

Tel.: +41 61 873 90 93
Fax +41 61 873 90 94
www.amsi.ch
info@amsi.ch

01.155.xxx

Tropftrichter, graduiert, mit Tropfenzähler

Zylindrische Form, NS-Hülse und Kern, eingeschmolzene Tropfspitze und Druckausgleich, mit **Glasreiber**

Artikel-Nr.	Inhalt ml	NS	Bohrung mm		CHF / Stk.
01.155.001	50	14/23	12/2.5		
01.155.002	100	29/32	14/2.5		
01.155.003	250	29/32	19/4		
01.155.004	500	29/32	19/4		
01.155.005	1000	29/32	19/6		
01.155.006	2000	29/32	21/6		

Andere Grössen auf Anfrage

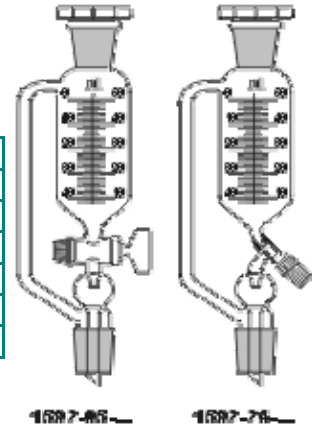

01.156.xxx

Tropftrichter, graduiert, mit Tropfenzähler

Zylindrische Form, NS-Hülse und Kern, eingeschmolzene Tropfspitze und Druckausgleich, mit **PTFE-Reiber**

Artikel-Nr.	Inhalt ml	NS	Bohrung mm		CHF / Stk.
01.156.001	50	14/23	12/2.5		
01.156.002	100	29/32	14/2.5		
01.156.003	250	29/32	14/2.5		
01.156.004	500	29/32	19/4		
01.156.005	1000	29/32	19/4		
01.156.006	2000	29/32	19/4		

Andere Grössen auf Anfrage

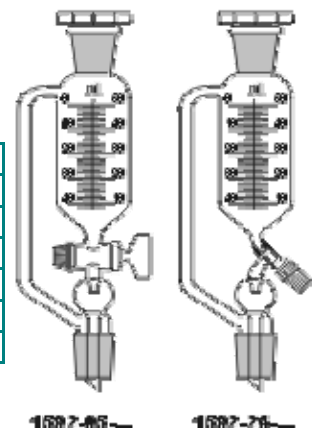

01.157.xxx

Tropftrichter, graduiert, mit Tropfenzähler

Zylindrische Form, NS-Hülse und Kern, eingeschmolzene Tropfspitze und Druckausgleich, mit **PTFE-Spindelhahn**

Artikel-Nr.	Inhalt ml	NS	Hahn mm		CHF / Stk.
01.157.001	50	14/23	0-2,5		
01.157.002	100	29/32	0-2,5		
01.157.003	250	29/32	0-2,5		
01.157.004	500	29/32	0-4		
01.157.005	1000	29/32	0-4		
01.157.006	2000	29/32	0-4		

Andere Grössen auf Anfrage

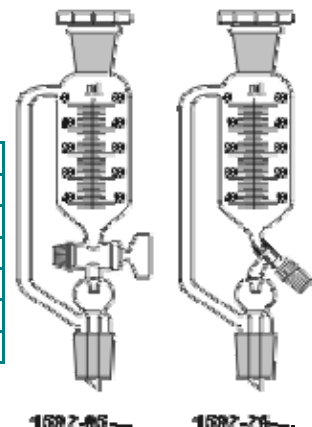

AMSI-Glas AG

Glasapparate, Labor- u. Pilottechnik

Geismet 11, Postfach 22
CH-4317 Wegenstetten

Tel.: +41 61 873 90 93
Fax +41 61 873 90 94
www.amsi.ch
info@amsi.ch

01.158.xxx

Tropftrichter mit Doppelmantel

Zylindrische Form, mit kompl. NS, Gewinde GL 14 und PE-Oliven, graduiert eingeschmolzene Tropfspitze, Druckausgleich, Tropfenzähler, mit **Glasreiber**

Artikel-Nr.	Inhalt ml	NS	Bohrung mm		CHF / Stk.
01.158.001	50	14/23	2.5		
01.158.002	100	19/26	2.5		
01.158.003	250	29/32	4		
01.158.004	500	29/32	4		
01.158.005	1000	29/32	6		
01.158.006	2000	29/32	6		

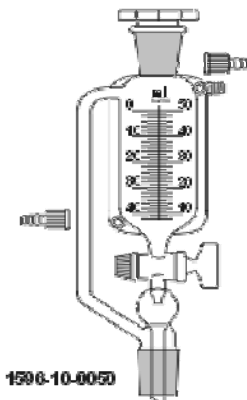

01.159.xxx

Tropftrichter mit Doppelmantel

Zylindrische Form, mit kompl. NS, Gewinde GL 14 und PE-Oliven, graduiert eingeschmolzene Tropfspitze, Druckausgleich, Tropfenzähler, mit **PTFE-Reiber**

Artikel-Nr.	Inhalt ml	NS	Bohrung mm		CHF / Stk.
01.159.001	50	14/23	2.5		
01.159.002	100	19/26	2.5		
01.159.003	250	29/32	4		
01.159.004	500	29/32	4		
01.159.005	1000	29/32	6		
01.159.006	2000	29/32	6		

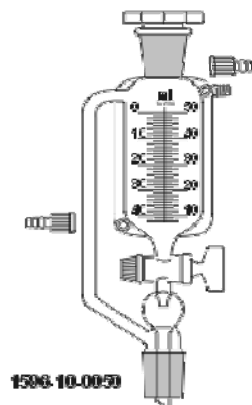

01.160.xxx

Pulvertrichter mit NS-Kern, aus Borosilikatglas

Artikel-Nr.	Rand-Ø mm	NS			CHF / Stk.
01.160.001	60	14/23			
01.160.002	70	14/23			
01.160.003	80	14/23			
01.160.004	100	14/23			
01.160.005	80	29/32			
01.160.006	100	29/32			
01.160.007	150	29/32			



Andere Grössen auf Anfrage

01.160.1xx

Pulver-Flachtrichter mit NS-Kern

Artikel-Nr.	Ø ca. mm	NS	Gesamthöhe ca. mm		CHF / Stk.
01.160.101	80	29/32	130		
01.160.102	100	29/32	152		
01.160.103	120	29/32	165		

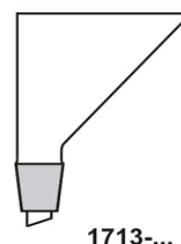

AMSI-Glas AG

Glasapparate, Labor- u. Pilottechnik

Geismet 11, Postfach 22
CH-4317 Wegenstetten

Tel.: +41 61 873 90 93
Fax +41 61 873 90 94
www.amsi.ch
info@amsi.ch

01.161.001

Destillations-Rücklaufteiler

Mit kompl. NS 29/32 für Rückflusskühler und Destillations-Kolonnen,
mit NS-Hülse 14/23 für Thermometer und NS-Kern 14/23 für Auffangkolben,
mit Spindelhahn handgeregelt, aus Borosilikatglas

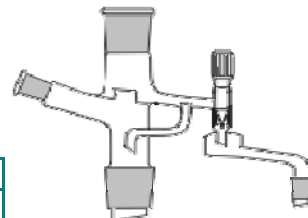

Artikel-Nr.					CHF / Stk.
01.161.001					

01.170.xxx

Kühlfallen für Vakuumapparaturen

Mit NS-Hülse und NS-Kern 29/32

Artikel-Nr.	Kühlmittel Inhalt ml				CHF / Stk.
Ohne Hahn					
01.170.001	200				
01.170.002	500				
01.170.003	1000				
Mit Spindelhahn					
01.170.004	200				
01.170.005	500				
01.170.006	1000				

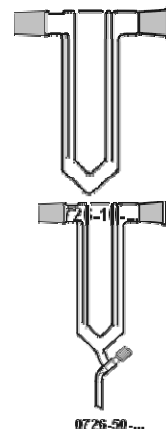

0726-50...

01.173.001

Hochvakuum-Ausfrierfalle nach Dr. Zellner

Aus Borosilikatglas

Artikel-Nr.	NS				CHF / Stk.
01.173.001	29/32				

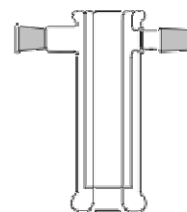

0727-100

01.174.xxx

Blasenzähler

Artikel-Nr.	Anschlüsse		Bauhöhe		CHF / Stk.
01.174.001	2 x GL14		100 mm		
01.174.002	2 x Oliven \varnothing 10 mm		100 mm		

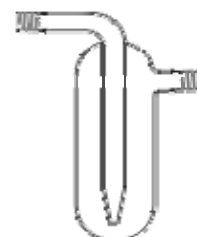

0729-100

AMSI-Glas AG

Glasapparate, Labor- u. Pilottechnik

Geismet 11, Postfach 22
CH-4317 Wegenstetten

Tel.: +41 61 873 90 93
Fax +41 61 873 90 94
www.amsi.ch
info@amsi.ch

01.175.001

Doppelkammer-Gasblasenzähler

Aufsatz mit NS-Kern 29/32 und Olive 10 mm, mit PP-Verschlusskappe

Artikel-Nr.	NS				CHF / Stk.
01.175.001	29/32				



0729-30-003

01.183.xxx

Kipp-Dosieraufsätze

Aus Borosilikatglas, mit NS-Kern 29/32, ohne Vorratsflasche

Artikel-Nr.	Inhalt ml				CHF / Stk.
01.183.001	1				
01.183.002	2				
01.183.003	4				
01.183.004	5				
01.183.005	10				
01.183.006	15				
01.183.007	20				
01.183.008	25				
01.183.009	30				
01.183.010	40				
01.183.011	50				
01.183.012	100				
Vorratsflasche					
01.183.013	1000	NS-H 29/32			

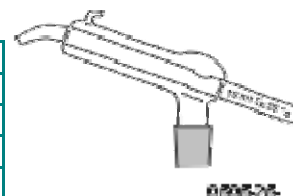

0829-20-



0906-30-

01.184.xxx

Auffangkolben nach Schlenk (Stickstoff-Rundkolben)

Rundkolben mit seittl. Glashahn NS 2,5 mm und Olive 8 mm

Artikel-Nr.	Inhalt ml	NS-Hülse			CHF / Stk.
01.184.001	25	14/23			
01.184.002	50	14/23			
01.184.003	100	14/23			
01.184.004	250	14/23			
01.184.005	500	14/23			
01.184.006	50	29/32			
01.184.007	100	29/32			
01.184.008	250	29/32			
01.184.009	500	29/32			
01.184.010	1000	29/32			



AMSI-Glas AG

Glasapparate, Labor- u. Pilottechnik

Geismet 11, Postfach 22
CH-4317 Wegenstetten

Tel.: +41 61 873 90 93

Fax +41 61 873 90 94

www.amsi.ch

info@amsi.ch

01.185.xxx

Auffangkolben nach Schlenk (Stickstoff-Kolben)

Zylindrische Form, seitl. Glashahn NS 2,5 mm und Olive 8 mm

Artikel-Nr.	Inhalt ml	NS-Hülse	Adm. x Länge mm		CHF / Stk.
01.185.001	10	14/23	16 x 120		
01.185.002	25	14/23	32 x 120		
01.185.003	50	14/23	32 x 145		
01.185.004	100	14/23	40 x 165		
01.185.005	250	14/23	48 x 220		
01.185.006	500	14/23	70 x 250		
01.185.007	50	29/32	32 x 145		
01.185.008	100	29/32	40 x 165		
01.185.009	250	29/32	48 x 220		
01.185.010	500	29/32	70 x 250		
01.185.011	1000	29/32	80 x 300		
01.185.012	2000	29/32	100 x 300		

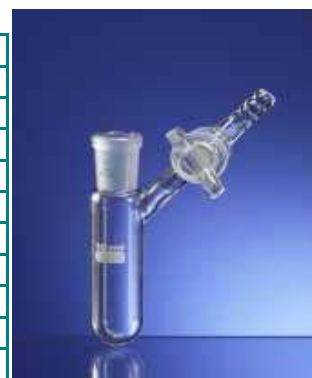

01.186.xxx

Temperierbecher aus Borosilikatglas, doppelwandig

Mit Olive					
Artikel-Nr.	Inhalt ml	Olive-Adm.	Innenmasse	Aussenmasse	CHF / Stk.
01.186.001	250	10	55 x 110	80 x 120	
01.186.002	250	10	75 x 60	100 x 90	
01.186.003	500	10	40 x 460	65 x 480	
01.186.004	500	10	75 x 130	105 x 150	
01.186.005	500	10	85 x 100	120 x 120	
01.186.006	600	10	77 x 135	100 x 145	
01.186.007	1000	10	90 x 190	115 x 220	
01.186.008	2000	12	112 x 225	140 x 235	
01.186.009	3000	12	125 x 270	135 x 300	
Mit Gewinde GL					
01.186.010	250	GL 14	55 x 110	80 x 120	
01.186.011	600	GL 14	77 x 135	100 x 145	
01.186.012	1000	GL 14	90 x 190	115 x 220	
01.186.013	2000	GL 14	112 x 225	140 x 235	
01.186.014	3000	GL 14	125 x 300	165 x 320	

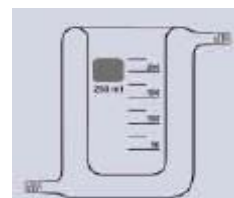

AMSI-Glas AG

Glasapparate, Labor- u. Pilottechnik

Geismet 11, Postfach 22
CH-4317 Wegenstetten

Tel.: +41 61 873 90 93

Fax +41 61 873 90 94

www.amsi.ch

info@amsi.ch

01.187.xxx

Schröpfgläser aus Borosilikatglas

Artikel-Nr.	Öffnung \varnothing innen			CHF / Stk.
01.187.001	2,5			
01.187.002	3,5			
01.187.003	4,5			
01.187.004	5,5			
01.187.005	6,5			
		mit Olive		
01.187.006	2,5	9 mm		
01.187.007	3,5	9 mm		
01.187.008	4,5	10 mm		
01.187.009	5,5	10 mm		
01.187.010	6,5	10 mm		
		mit Olive und Saugball		
01.187.011	2,5	9 mm		
01.187.012	3,5	9 mm		
01.187.013	4,5	10 mm		
01.187.014	5,5	10 mm		
01.187.015	6,5	10 mm		



Andere Grössen auf Anfrage

01.188.xxx

Sauggläser nach Bier (Saugglocke) aus Borosilikatglas

Mit Olive					
Artikel-Nr.		\varnothing cm			CHF / Stk.
01.188.001		3,0			
01.188.002		4,0			
01.188.003		5,0			
01.188.004		6,0			
		Mit Olive und Saugball			
01.188.005		3,0			
01.188.006		4,0			
01.188.007		5,0			
01.188.008		6,0			

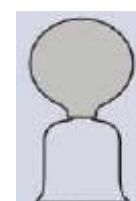

AMSI-Glas AG

Glasapparate, Labor- u. Pilottechnik

Geismet 11, Postfach 22
CH-4317 Wegenstetten

Tel.: +41 61 873 90 93
Fax +41 61 873 90 94
www.amsi.ch
info@amsi.ch

01.190.xxx

Zweihals-Aufsätze aus Borosilikatglas

Zwei NS-Hülsen parallel

Artikel-Nr.	NS-Kern	2 NS-Hülsen			CHF / Stk.
01.190.001	14/23	14/23			
01.190.002	29/32	14/23			
01.190.003	29/32	29/32			



Andere Grössen auf Anfrage

01.191.xxx

Zweihals-Aufsätze aus Borosilikatglas

Mit zwei NS-Hülsen im Winkel von 75°

Artikel-Nr.	NS-Kern	2 NS-Hülsen			CHF / Stk.
01.191.001	14/23	14/23			
01.191.002	29/32	14/23			
01.191.003	29/32	29/32			



01.192.xxx

Rundkolben-Vorratsgefäss aus Borosilikatglas

Mit Glashahn

Artikel-Nr.	Inhalt ml	NS-Hülse	NS-Hahn		CHF / Stk.
01.192.001	250	29/32	14/2,5 mm		
01.192.002	500	29/32	14/2,5 mm		
01.192.003	1000	29/32	19/4 mm		
01.192.004	2000	29/32	19/4 mm		

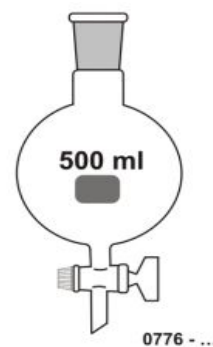

0776 - ...

Mit PTFE-Hahn oder Spindelhahn auf Anfrage

01.193.xxx

Destillieraufsatz nach Reitmayer, aus Borosilikatglas

Einschmelzung mit Balken, Kugel- \varnothing ca. 60 mm

Artikel-Nr.	NS-Hülse	NS-Kern			CHF / Stk.
01.193.001	14/23	14/23			
01.193.002	29/32	14/23			
01.193.003	29/32	29/32			



0963-....